

## ORGANIZERS AND ACCESSORIES



Our organizers and accessories offer functional storage solutions that help you create a thoughtfully designed and beautifully organized space—creating room for your wonderful everyday.

Choose from our curated selection of drawer organizers, made from wood or steel, as well as waste sorting solutions, cabinet organizers, and lighting.

Discover all options in this catalog.

## Table of contents

05 Drawer organizers

05 Wood drawers

21 Steel drawers

35 Cabinet organizers

51 Lighting



4

## 5 Drawer organizers / wood drawers

All drawers can be ordered with organizers—designed to support the rhythm of everyday life.

Organizers for wooden drawers are crafted from solid oak and are available in natural oak, smoked oak, or ash. Choose from knife racks, cutlery trays, spice holders, plate holders, and multi-compartment inserts—all designed to keep your kitchen essentials beautifully in place.

Waste sorting solutions are available in a range of configurations to suit your specific waste streams, complete with plastic waste bins and lids.

Drawer organizers / wood drawers / width 40

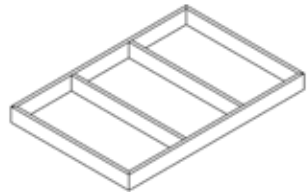

Divider U1 / W40 D60

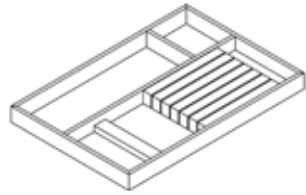

Divider U12 / W40 D60

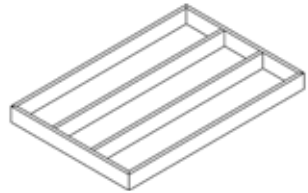

Divider U3 / W40 D60

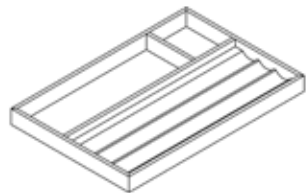

Divider 22 / W40 D60

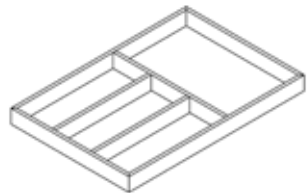

Divider U4 / W40 D60

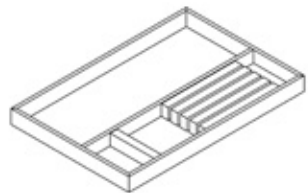

Divider U7 / W40 D60

Dividers fit in low, medium, and high drawers with a depth of up to 60cm.

7



Medium drawer in natural oak with divider U5

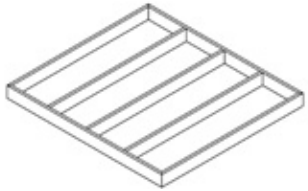

Divider U1 / W60 D60

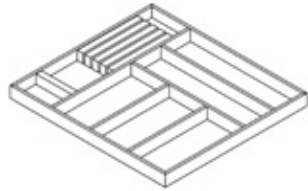

Divider U8 / W60 D60

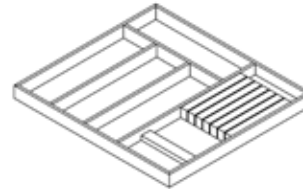

Divider U14 / W60 D60

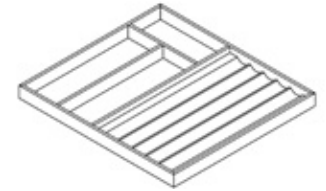

Divider U25 / W60 D60

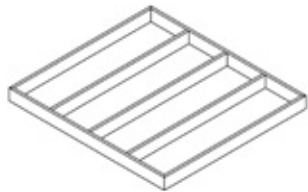

Divider U2 / W60 D60

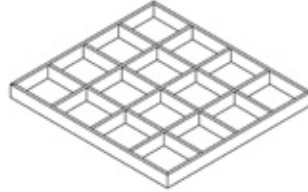

Divider U10 / W60 D60

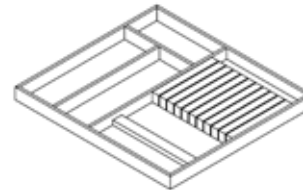

Divider U15 / W60 D60

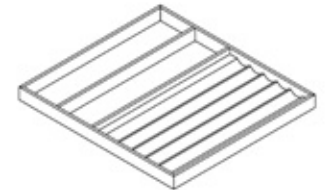

Divider U26 / W60 D60

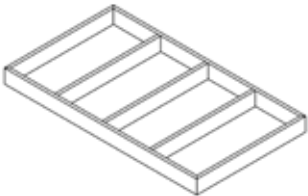

Divider U2 / W60 D30

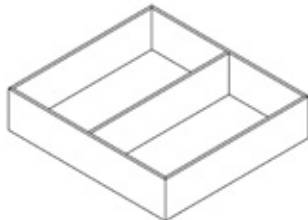

Divider U11 / W60 D60 \*

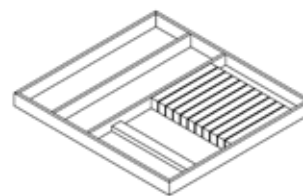

Divider U16 / W60 D60

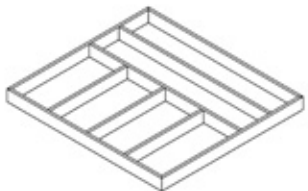

Divider U5 / W60 D60

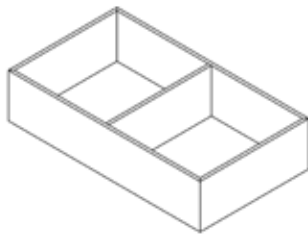

Divider U11 / W60 D30 \*

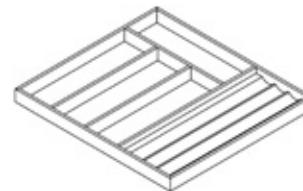

Divider U24 / W60 D60

Dividers fit in low, medium, and high drawers with a depth of up to 60cm.

\* Will only fit in medium or high drawers.

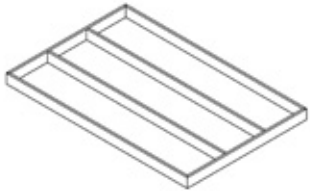

Divider U1 / W80 D60

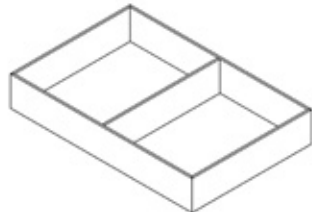

Divider U11 / W80 D60 \*

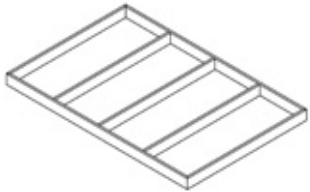

Divider U2 / W80 D60

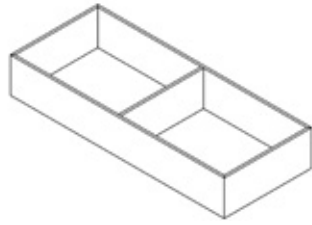

Divider U11 / W80 D30 \*

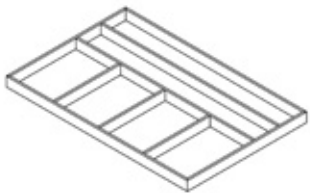

Divider U5 / W80 D60

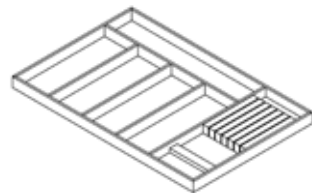

Divider U17 / W80 D60

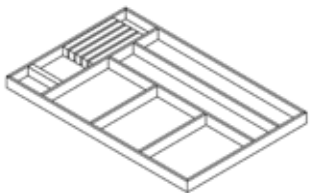

Divider U8 / W80 D60

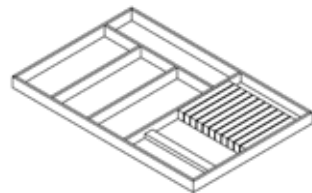

Divider 18 / W80 D60

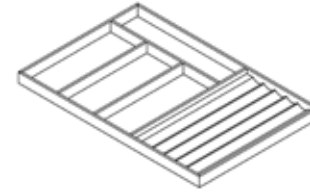

Divider U28 / W80 D60

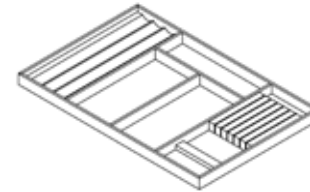

Divider U2 / W80 D600

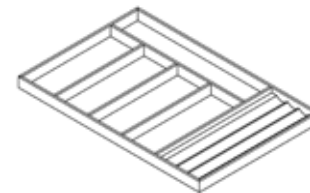

Divider U27 / W80 D60

Dividers fit in low, medium, and high drawers with a depth of up to 60cm.

\* Will only fit in medium or high drawers.

## Drawer organizers / wood drawers / plate holders



Plate holder

One size—expandable to fit plates 200mm-280mm.

Plate holders are available in natural oak or steel and fit high drawers.

13



High drawer in natural oak with plate holder



14

Low drawer in natural oak with spice rack

15



Low drawer in smoked oak with divider U8

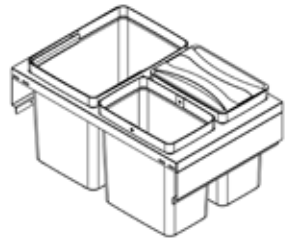

Waste sorting solution / W60 D50

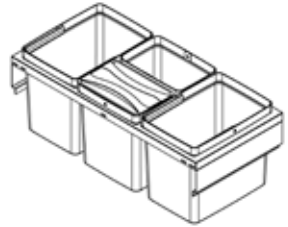

Waste sorting solution / W80 D50

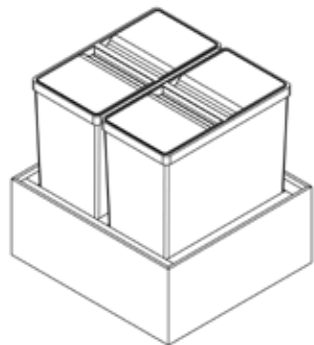

Waste sorting solution / W60 D60

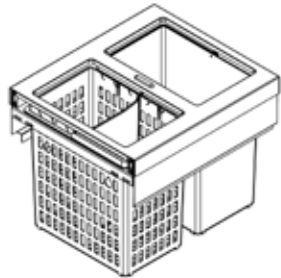

Waste sorting solution / W40 D60

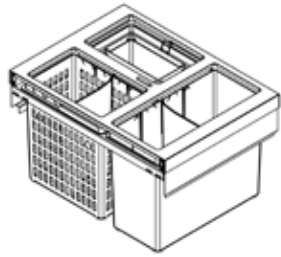

Waste sorting solution / W60 D60

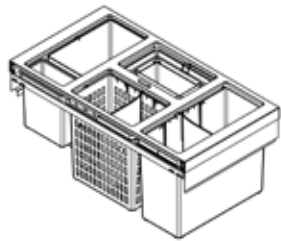

Waste sorting solution / W80 D60





18

High drawer in dark oak with waste sorting solution W60

19



High drawer in smoked oak with waste sorting solution W80

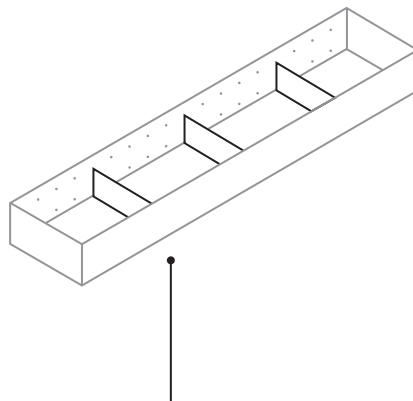
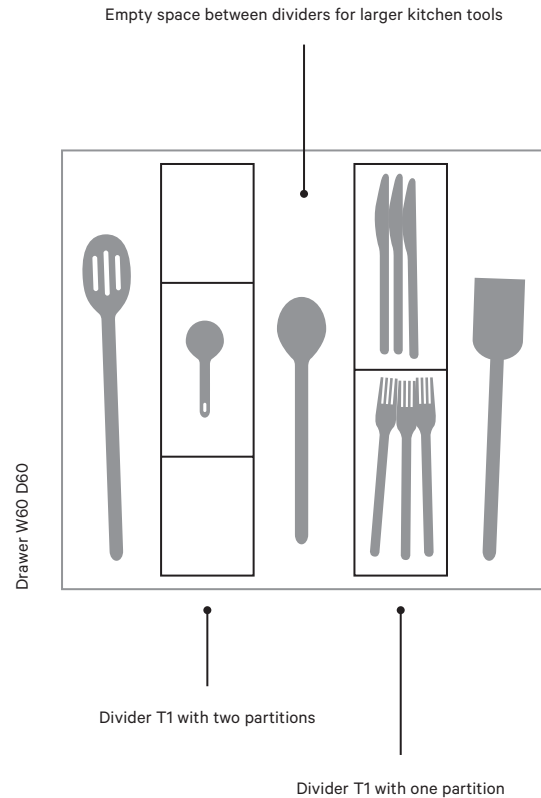

Divider T1 with three partitions. Use partitions to creation room for smaller items.

For steel drawers, organizers are available in black or white steel. Organizers include knife racks, cutlery trays, spice holders, plate holders, and multiple-compartment inserts designed to support the rhythm of everyday life.

The illustrated sets on the following pages show suggested configurations, but the system is modular. You can create your own arrangement by planning dividers and partition walls individually. We're here to guide you through the process, ensuring a solution tailored to your space.

Waste sorting solutions are available in a range of configurations to suit your specific waste streams, complete with plastic waste bins and lids.

# Drawer organizers / steel drawers

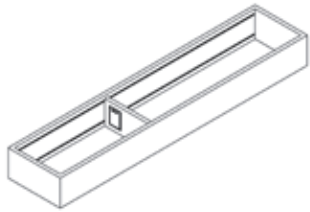

Divider T1

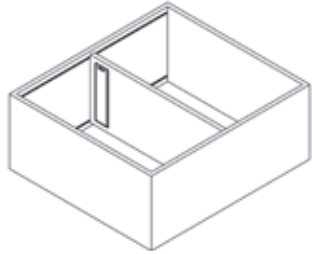

Divider T5

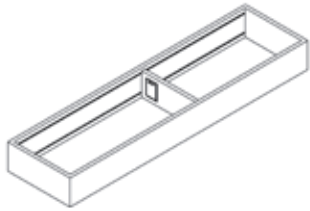

Divider T2

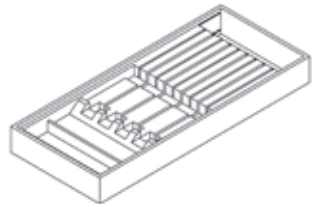

Knife holder

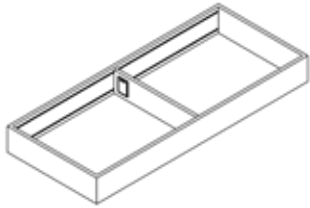

Divider T3

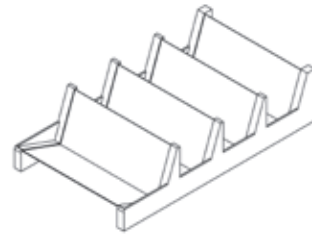

Spice rack

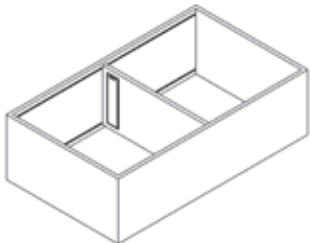

Divider T4

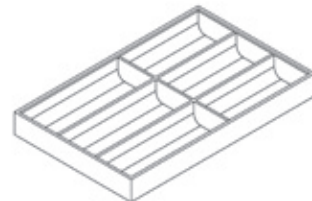

Cutlery tray



Small drawer in black steel with T1, T2, and knife holder

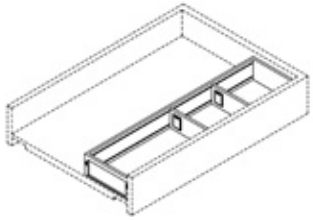

S40-3

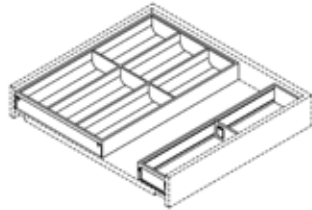

S60-1

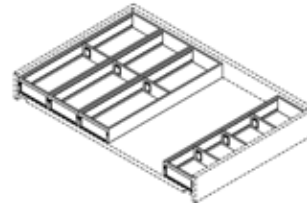

S80-2

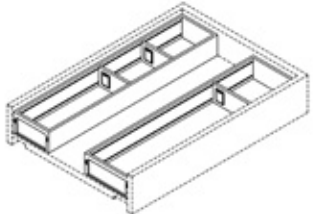

S40-1

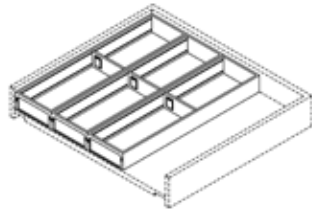

S60-2

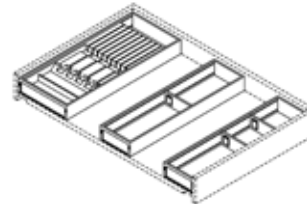

S80-3

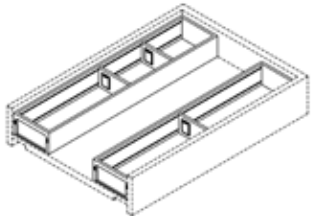

S40-2

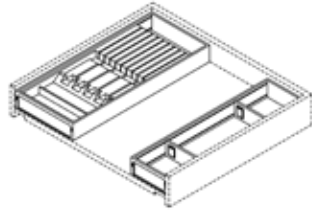

S60-4

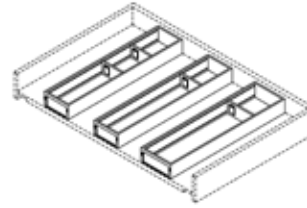

S80-4

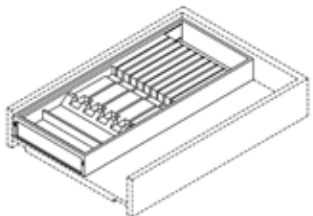

S40-4

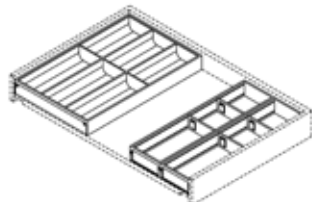

S60-3

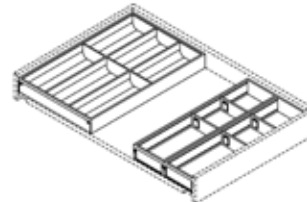

S80-1

Dividers fit in low, medium, and high drawers with a depth of 60cm.  
\* Will only fit in high drawers.

26



Medium drawer in white steel with dividers T1 and T2

27



Medium drawer in black steel with dividers T1 and T2

28



Medium drawer in white steel with cutlery tray

29



Medium drawer in black steel with cutlery tray

30



High drawer in black steel with divider T4 and spice rack

31



High drawer in white steel with divider T4

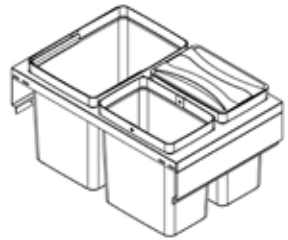

Waste sorting solution / W80 D50

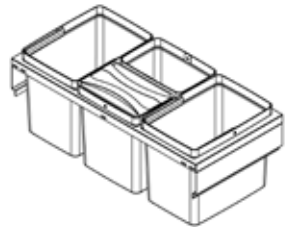

Waste sorting solution / W80 D50



High drawer in black steel with waste sorting solution W60



34

Base cabinet with pull-out W20

## 35 Cabinet organizers

Available in a range of configurations and finishes, our cabinet organizers help you make the most of every corner.

Pull-out organizers for base, high, and corner cabinets, as well as utility sets for tall cabinets, keep essentials within easy reach. Additional features—including vertical opening cabinets, pull-down, pull-out, and turning shelves—help support the way you live and move in your space.

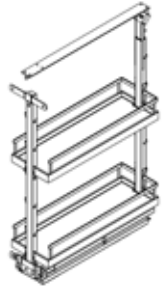

Pull-out for base cabinet / W20 H80 D60

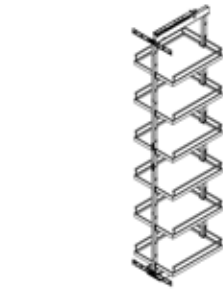

Pull-out for high cabinet / W40 H200 / H220

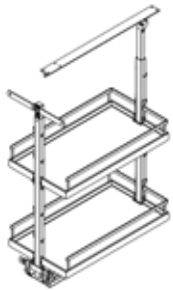

Pull-out for base cabinet / W20 H80 D60

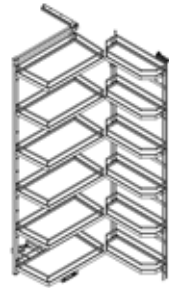

Pull-out for high cabinet / W60 H200 / 220

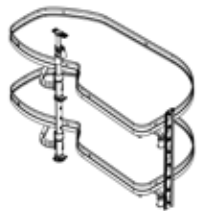

Pull-out for corner cabinet / W127 H80 D60



Carousel for corner cabinet / W88 H80 D88



Pull-down for wall cabinet  
Double shelf / W60 D30



Pull-down for wall cabinet  
Single shelf / W60 D30



Pull-out shelf / W40 D60



Pull-out shelf / W60 D60



Pull-out shelf / W80 D60



Turning shelf / W30 D30



High cabinet with pull-out W60



High cabinet with pull-out W40





Corner cabinet with pull out



Wall cabinet with single shelf pull-down



46



Wall cabinet with double shelf pull-down

47



High cabinet with turning shelf and pull-out shelf

Cabinet organizers / width 40, 60, 80

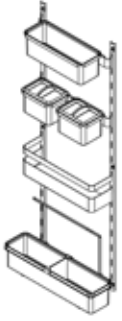

Utility set small / W60

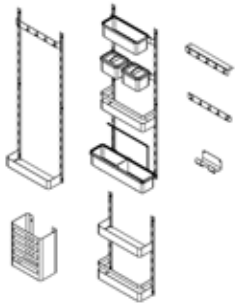

Utility set large / W60



Cabinet with utility set large W60



50

LED spotlights

## 51 Lighting

Our LED recessed spotlights are available in stainless steel, black, or raw brass and can be mounted directly into your kitchen cabinets, designed to illuminate countertops. Our strip lights are fully integrated interior lights designed for drawers and cabinets. These lighting options are designed to bring focused light exactly where you need it—without interrupting the flow of your space.

# Light



LED light / Ø3



Strip light / W40, 60, 80, 120

[reformcph.com](http://reformcph.com) / [#reformcph](https://twitter.com/reformcph)

Reform